

Article number: 203150M1260B2S

Description: E+G levelling foot
GN 31-50-M12-60-B2-S

Note: S Without nut, External hexagon at the bottom

Measures

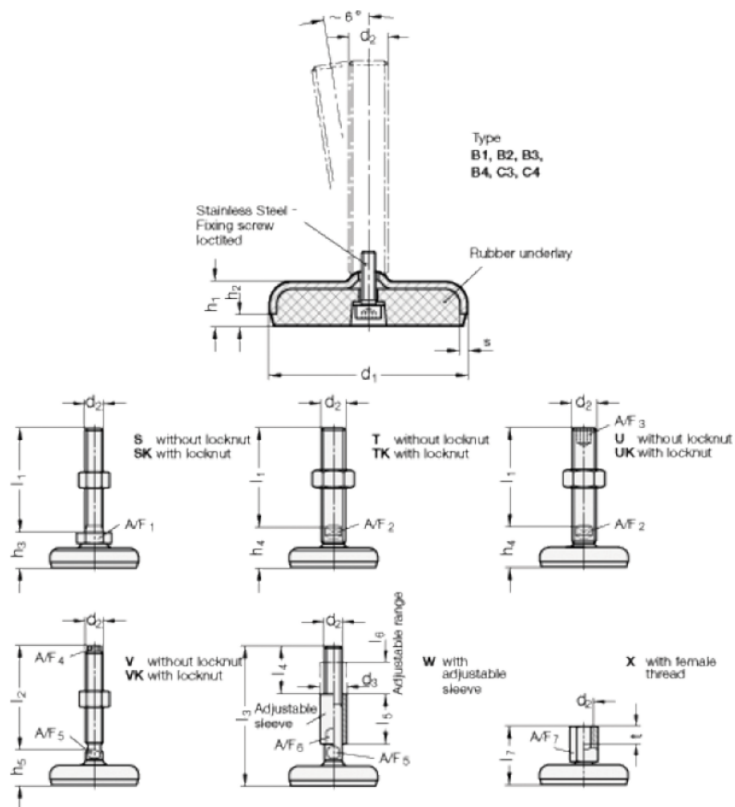

A/F1-	= 17
d1	= 50
d2	= 12
h1	= 14.5
h2	= 3.5
h3 +4.0/0	= 23
l1	= 60
s	= 3